

BIRCHWOOD

Homes



SOUTHVALE 44 LOOK BOOK

Front & Right Elevations



Left & Rear Elevations



Exterior Finishes



BLACK CLAD WINDOW



BLACK GUTTERS

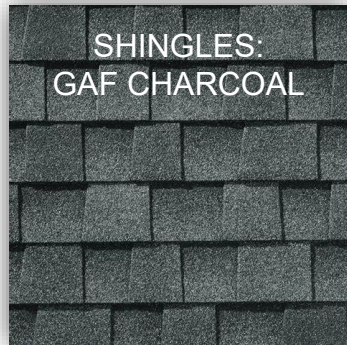

**SHINGLES:
GAF CHARCOAL**

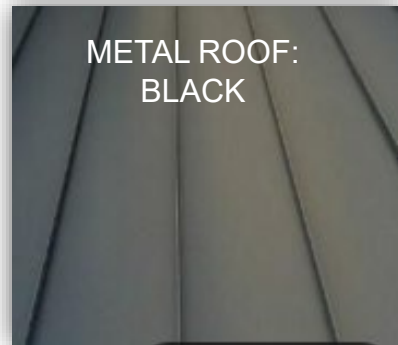

**METAL ROOF:
BLACK**

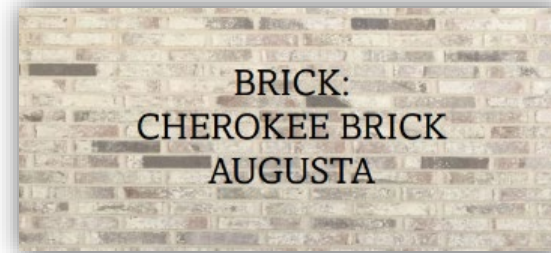

**BRICK:
CHEROKEE BRICK
AUGUSTA**

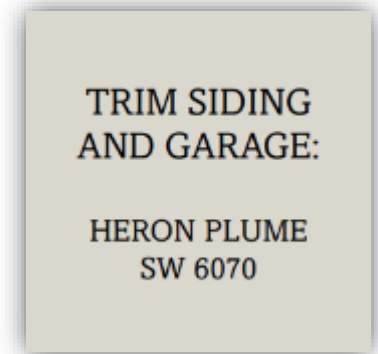

**TRIM SIDING
AND GARAGE:

HERON PLUME
SW 6070**

Main level

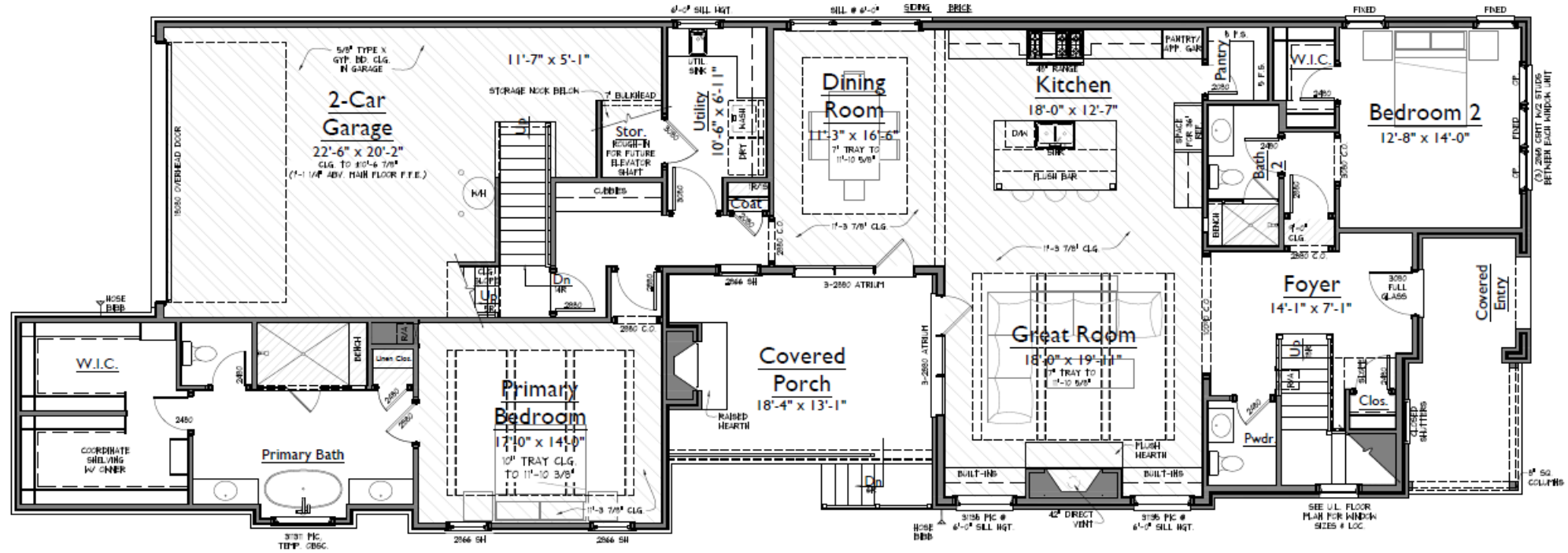

Kitchen

CABINET HARDWARE



HARDWOOD:
Laakso Valley



Perimeter Cabinets:
Snow



ISLAND STAIN:
White Oak to
coordinate with
flooring.

ISLAND PENDANTS



**ARCUSTONE HOOD INSPIRATION
COLOR: WHITE**

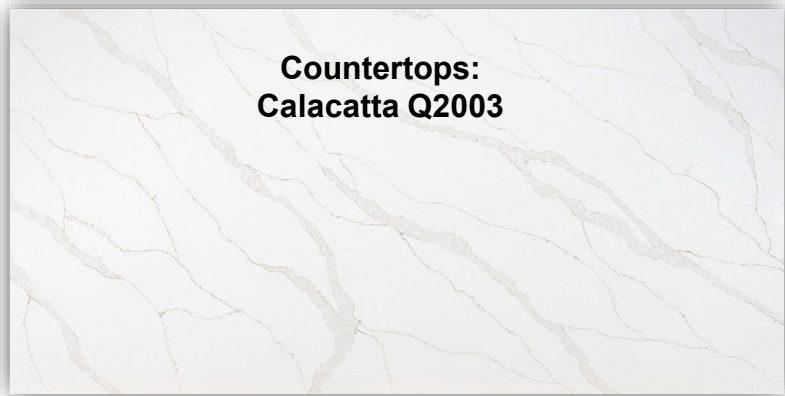

Countertops:
Calacatta Q2003



Backsplash Tile:
3x8 Cloe Gray



**DELTA TRINSIC IN CHAMPAGNE
BRONZE WITH UNDERMOUNT
BLANCO SINK IN WHITE. DRAIN TO
MATCH.**



BIRCHWOOD
Homes

Great Room

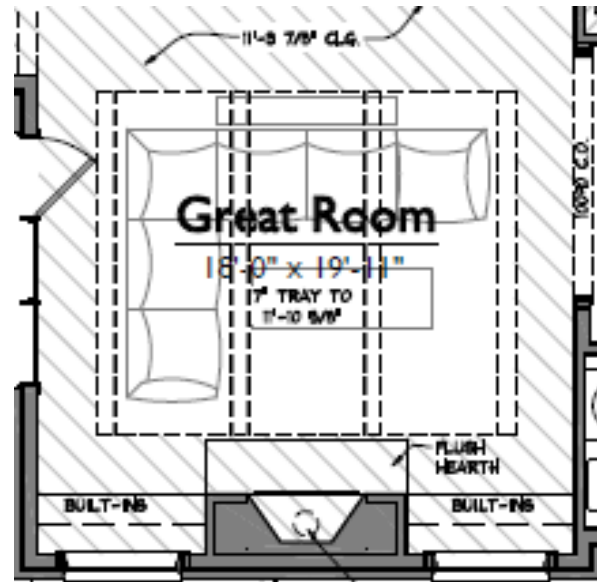

8" STAIN GRADE PINE BEAMS
INSIDE TRAY



BUILT IN INSPIRATION



Primary Bedroom

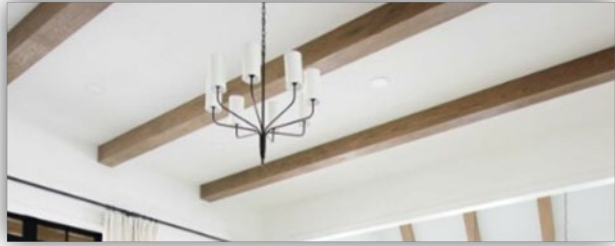

8" STAIN GRADE PINE BEAMS AT TRAY

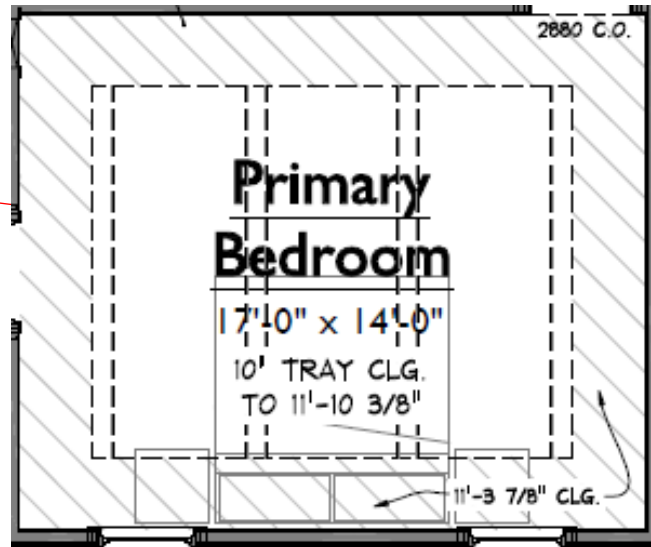

HARDWOOD:

**7.5" Planks
Color: Laakso Valley**



Primary Bath

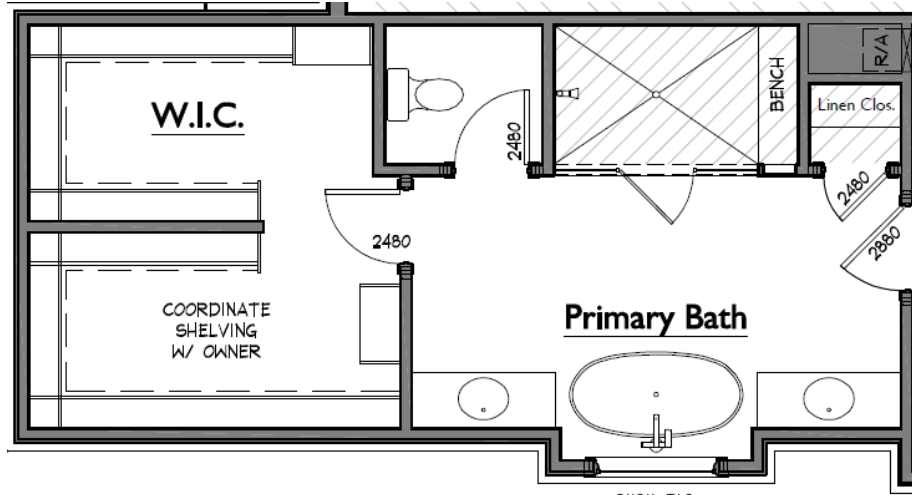

Floor Tile 24x24 Volakas Grigio Honed
Wall Tile 24x48 Volakas Grigio Polished
Shower Floor Volakas Grigio Honed Weave Mosaic

Grout: Custom Ash

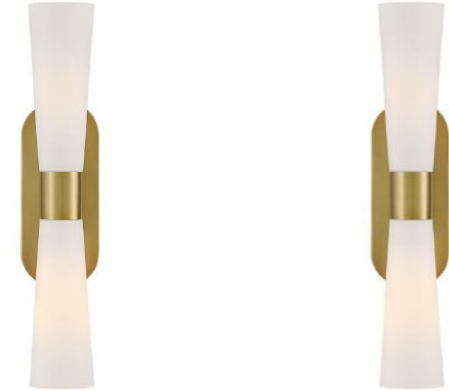

WHITE OAK VANITIES
STAINED: To Coordinate with
Hardwood



DELTA SAYLOR FAUCETS
CHAMPAGNE BRONZE



COUNTERTOP: Q2004 CALACATTA

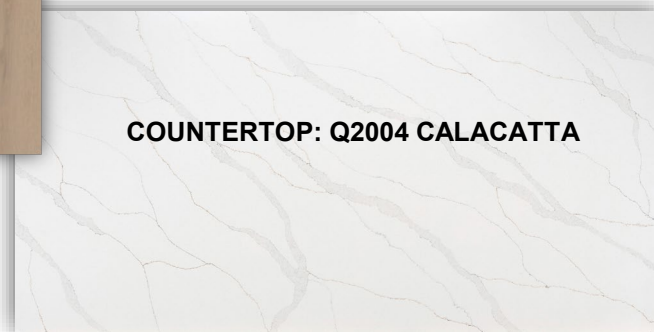

PALOMA FREE STANDING TUB

BIRCHWOOD
Homes

Utility room



Floor Tile:
Davenport ash 12x24
Grout: Sterling

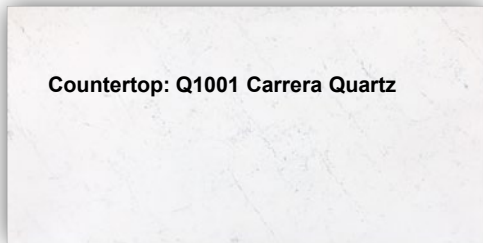

Countertop: Q1001 Carrera Quartz

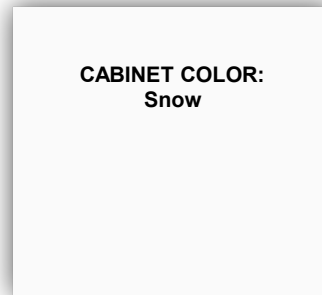
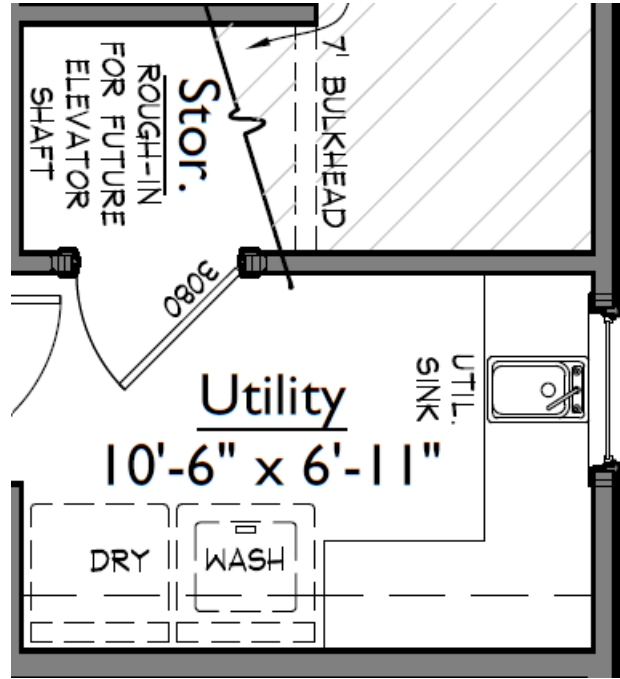

CABINET COLOR:
Snow



BLANCO UNDERMOUNT SINK
DELTA CZ FAUCET

Powder Bath



CABINET HARDWARE



**REEDED VANITY
INSET DOORS
PAINTED**



**DELTA SAYLOR
CHAMPAGNE BRONZE**



**COUNTERTOP:
Calacatta 2003**

Bath 2

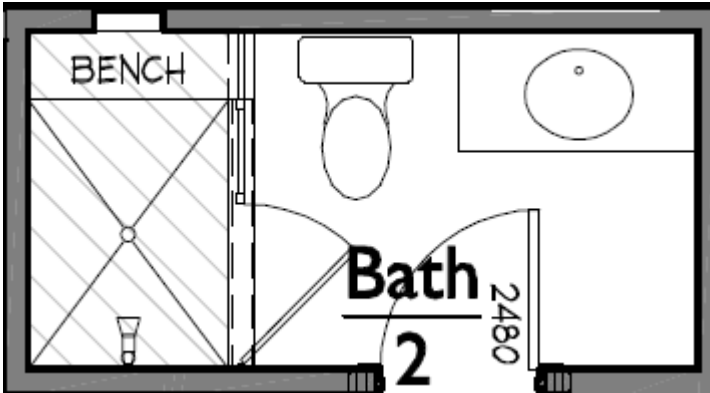

**Shower Walls: Serena
White 4x4 Polished.**



**Bathroom Floor: Dolomite
Matte 12x24 Staggered**



**DELTA SAYLOR CHAMPAGNE
BRONZE FAUCET & SHOWER TRIM**

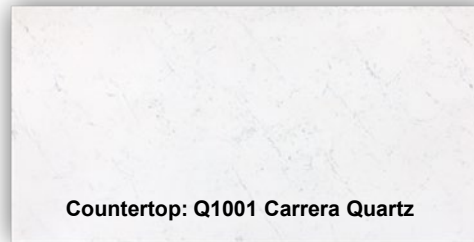

Countertop: Q1001 Carrera Quartz



**Cabinet Color:
Fog**

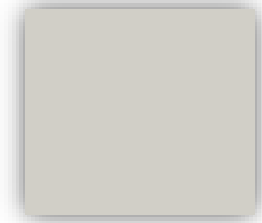

CABINET HARDWARE

Bath 3

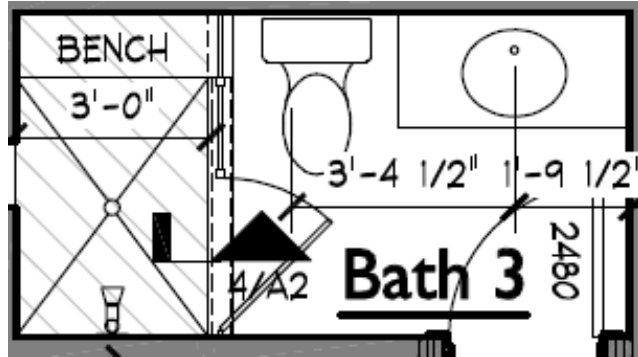

DELTA SAYLOR FAUCET AND SHOWER TRIM

Cabinet Color: Fog



Shower Walls: Soho Canvas White 2x12 Glossy Laid Herringbone



Floor Tile: Stone peak White Desert 12x24

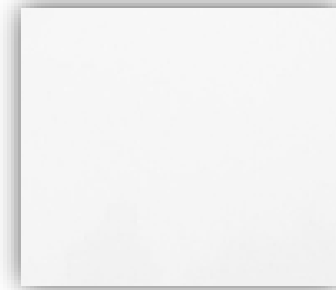

Countertop: GSD Pure White



M1570

CABINET HARDWARE

Bath 4

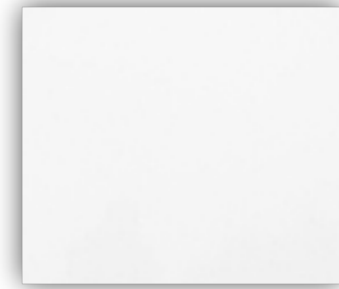
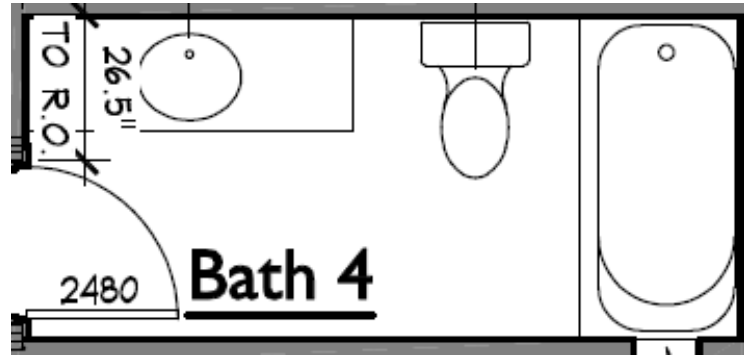

Countertop: GSD Pure White

Cabinet Color: Pacific Sand



FLOOR TILE: Dolomite Matte 12X24
Grout: Custom Ash

SHOWER WALLS: Ice White Gloss 4x12



DELTA SAYLOR FAUCT AND SHOWER TRIM



CABINET HARDWARE

Bath 5

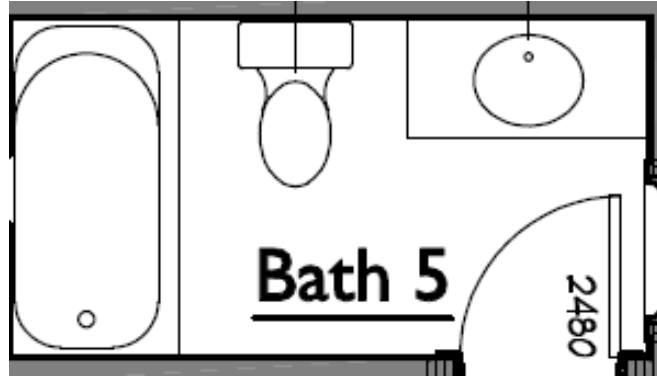

Countertop: GSD Pure White

Cabinet Color: Pacific Sand



Floor Tile: 12x24 Honed Summer Breeze
Wall Tile: Plume 3x8 Gloss White



DELTA SAYLOR FAUCT AND SHOWER TRIM



CABINET HARDWARE

Kitchen Appliances



KitchenAid KFGC558JSS

48 Inch Wide 6.3 Cu. Ft. Free Standing Gas Range with Three-Level Convertible Grates



Trade-Wind VSL44812RC

VSL400 Series 1,200 CFM 48 Inch Wide Range Hood Insert with Remote and LED Lighting



KitchenAid KDTE204KPS

24 Inch Wide 13 Place Setting Built-In Top Control Dishwasher with Third Level Utensil Rack



Sharp SMD2470ASY

24 Inch Wide 1.2 Cu. Ft. Microwave Drawer with Push Button Opening

Flooring



HARDWOOD:

**RW SILVIAN 7.5" PLANK
COLOR: Laakso Valley**

LOCATIONS:

**PRIMARY BED & CLOSETS, BED 2 & CLOSET, POWDER BATH,
MAIN LIVING, UP HALL AND HALL CLOSET**



CARPET:

**STYLE: FILIGREE
COLOR: SILVER**

LOCATIONS:

BEDS 3, 4, & 5 WITH CLOSETS & BONUS ROOM

Decorative Lighting



3D-946441BK
FRONT BRACKET



6L-PCC1008GD
FOYER



8A-85412DA
POWDER



3T-TEA52W4
BED 2



3D-149431AD-543
BATH 2



3D-448901AD
GREAT ROOM 12'C



17U-QP5597W
KITCHEN (x2)



PORCH



13J-29908VB
PRIMARY BED 12'C



8A-85632LCB
PRIMARY BATH (x4)

Decorative Lighting



3D-155231AD-550
BATH 3



3D-151731AD
BATH 4



8A-85003LCB
BATH 5



6L-8737401-12
GARAGE BRACKET (x2)



Interior Paint

**All trim & Ceilings,
Pantry**

**SW Snowbound
7004**

**Main walls & All
Beds/Baths & Bonus
room walls/trim**

SW Drift of Mist 9166

Mirrors



Primary bath, bath 2, 3, 4 & 5

Plate glass mirror with bevels

Porch Finishes



Porch concrete cut in decorative diagonal pattern



Inspiration: Fireplace with raised hearth and mantle.

Mud Room Cubbies



Mud Room
cubby inspiration
with stained
white oak bench.

Interior Trim

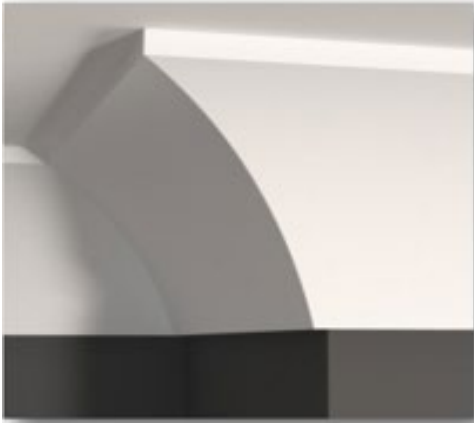

7 1/4" CROWN: W-505



CASING: W-342



BASEBOARD: W-163B



SHOE MOLD: W-8127



DOOR HARDWARE



3 PANEL FLAT INTERIOR DOORS
SOLID CORE

Interior Trim



Painted ridge beam in bonus/bed 3



Stairwell Wall trim Inspiration



Primary bed and family room box beam inspiration. Stained to coordinate with floor

Stair Parts



STAINED CONTEMPORARY RAIL
ROUND 5/8" IRON BALUSTERS (NO BOOTS)
SQUARE MODERN NEWELS